

ONLY FOR BOATS WITHOUT TRS DRIVES

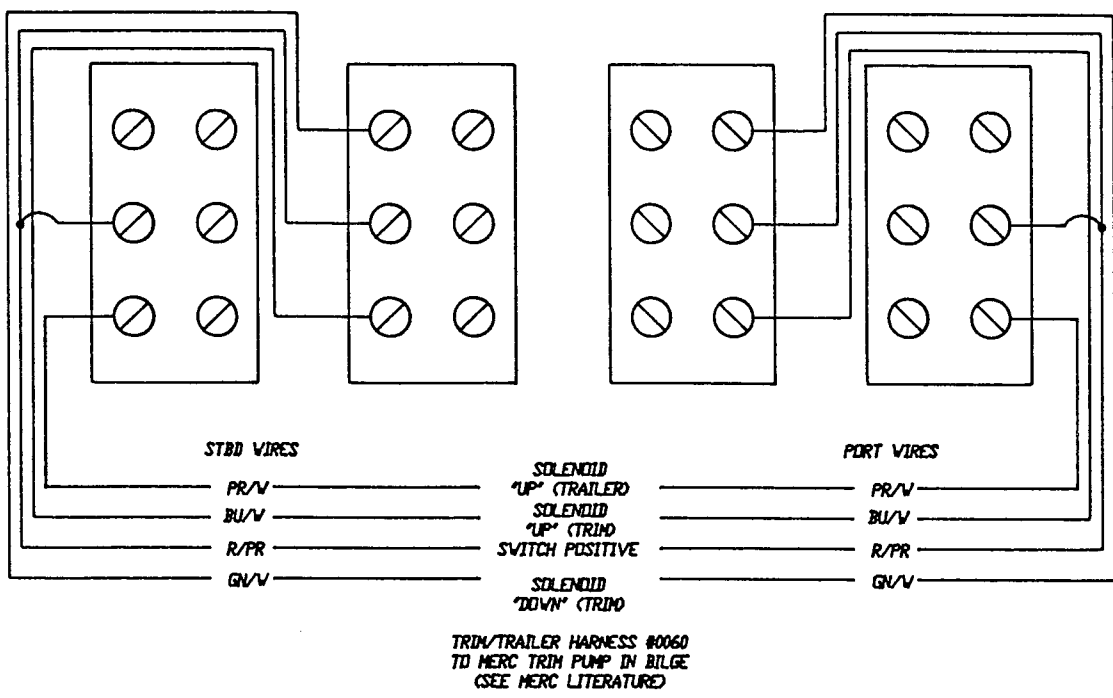

TRIM/TRAILER HARNESS #0060  
TO MERC TRIM PUMP IN BILGE  
(SEE MERC LITERATURE)

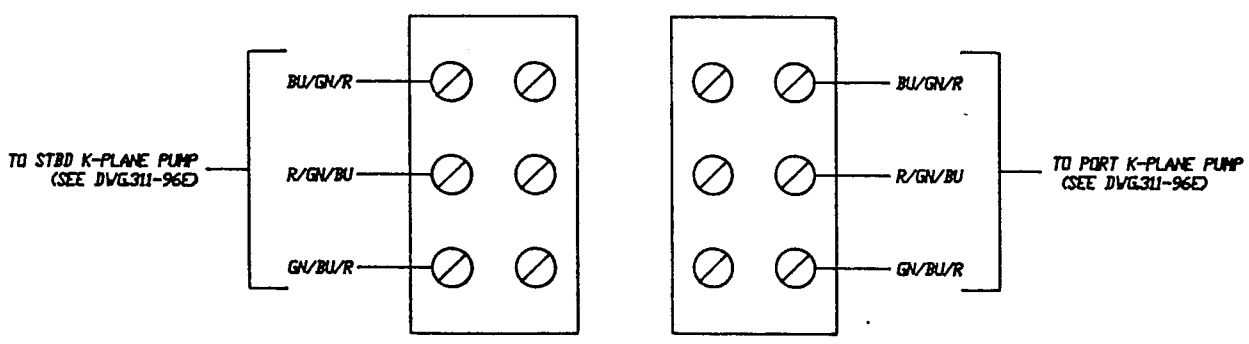
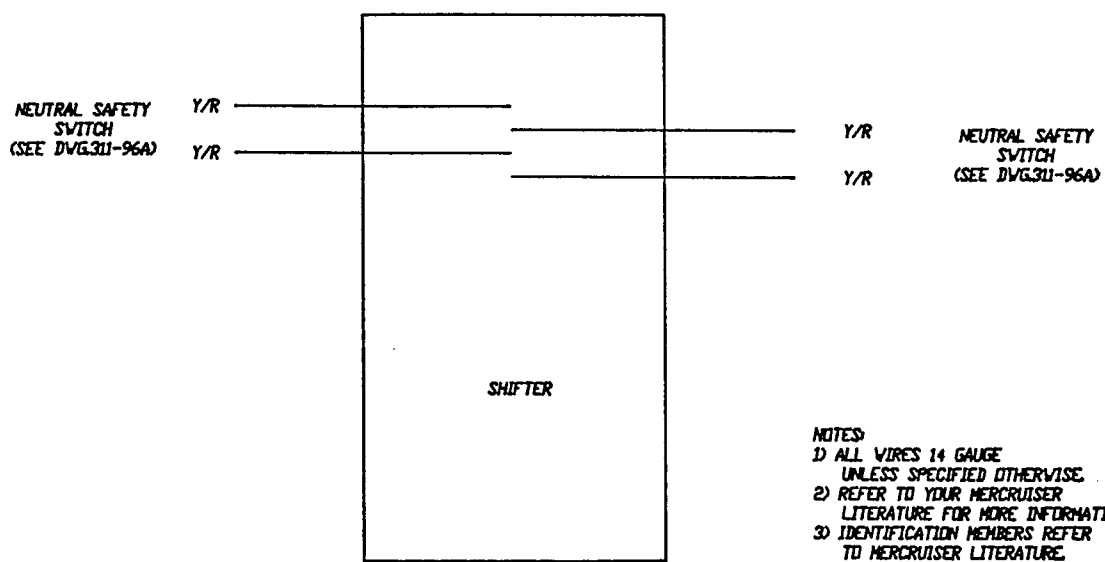

- NOTES
- 1) ALL WIRES 14 GAUGE UNLESS SPECIFIED OTHERWISE.
  - 2) REFER TO YOUR MERCUISER LITERATURE FOR MORE INFORMATION.
  - 3) IDENTIFICATION MEMBERS REFER TO MERCUISER LITERATURE.

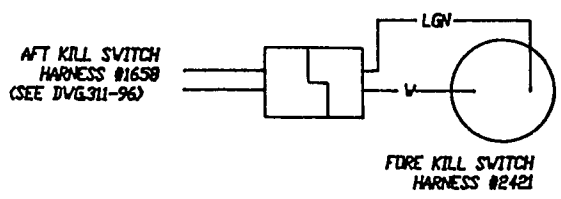

FORE KILL SWITCH HARNESS #2421

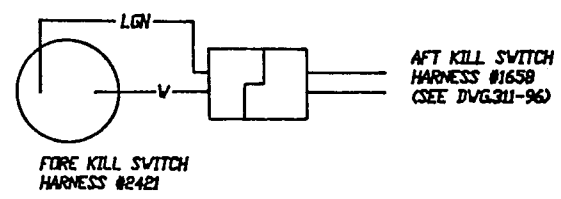

FORE KILL SWITCH HARNESS #2421

TITLE: F-311 SRI		TO HIN # *	FROM HIN # *	DR	CH	DATE
SHIFTER WIRING		TO HIN # *	FROM HIN # *			
DIAGRAM		TO HIN # *	FROM HIN # *			
DR BY: KKR		TO HIN # *	FROM HIN # *			
CH BY: JZ		TO HIN # *	FROM HIN # MY89			
DATE: 1/7/88		TO HIN # *				
INO: 311-96L1						
REVISIONS						
4						
3						
2						
1						

THUNDERBIRD PRODUCTS  
P.O. BOX 501  
DECATUR, IN 46733  
(219) 724-9111

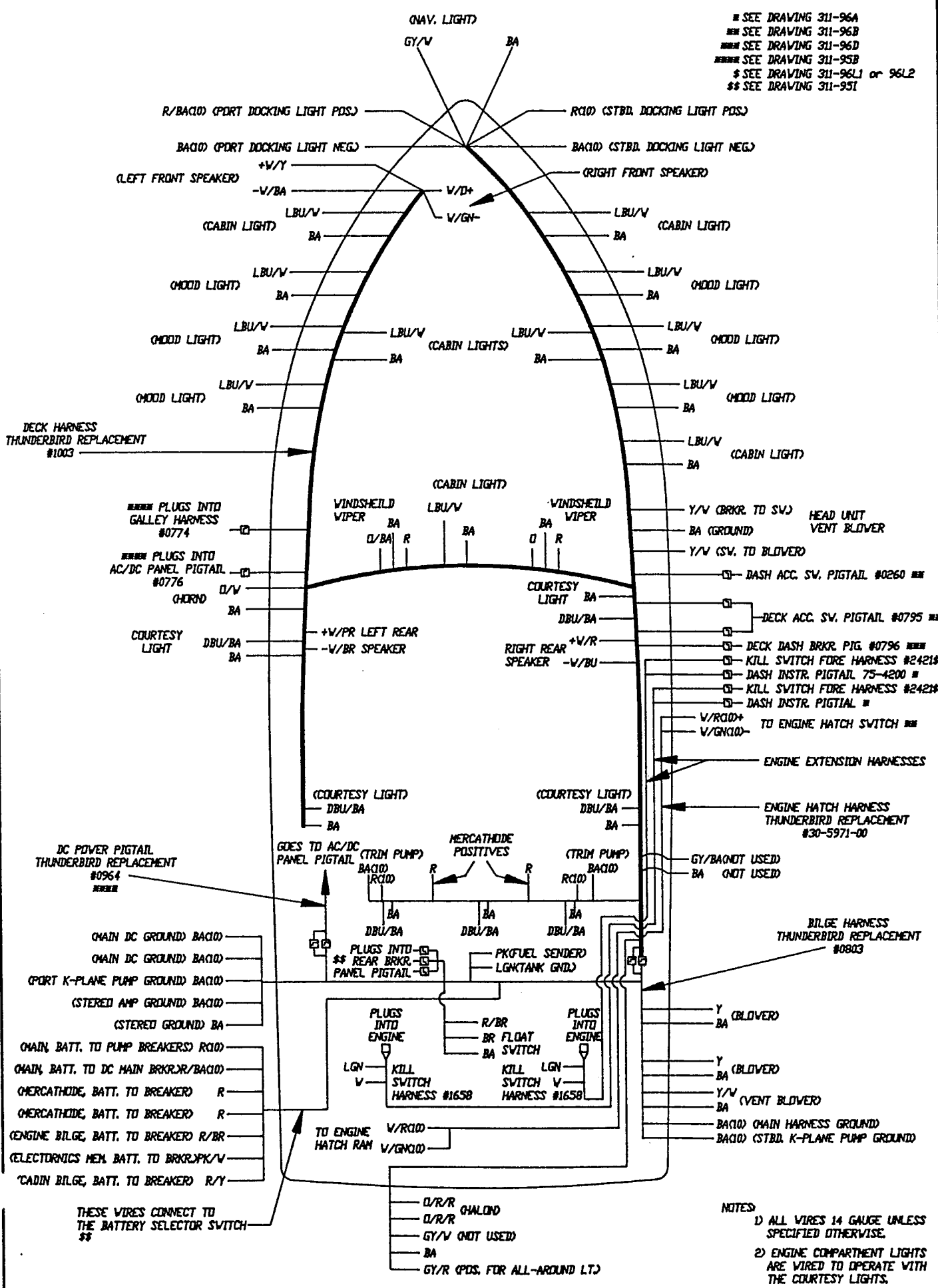

■ SEE DRAWING 311-96A  
 ■ SEE DRAWING 311-96B  
 ■ SEE DRAWING 311-96C  
 ■ SEE DRAWING 311-95B  
 \$ SEE DRAWING 311-96L or 96L2  
 \$\$ SEE DRAWING 311-95I

TITLE: F-311 SR1 LAYOUT WIRING DIAGRAM		TO HIN #	TO HIN #	TO HIN #	TO HIN #	TO HIN #
FROM HIN #	FROM HIN #	FROM HIN #	FROM HIN #	FROM HIN #	FROM HIN #	FROM HIN #
DATE	DATE	DATE	DATE	DATE	DATE	DATE
DR	DR	DR	DR	DR	DR	DR
CH	CH	CH	CH	CH	CH	CH
REVISIONS	REVISIONS	REVISIONS	REVISIONS	REVISIONS	REVISIONS	REVISIONS
4	3	2	1	1	1	1
THUNDERBIRD PRODUCTS	P.O. BOX 501	DECATUR, IN 46733	(219) 724-9111			

NOTES:  
 1) ALL WIRES 14 GAUGE UNLESS SPECIFIED OTHERWISE.  
 2) ENGINE COMPARTMENT LIGHTS ARE WIRED TO OPERATE WITH THE COURTESY LIGHTS.

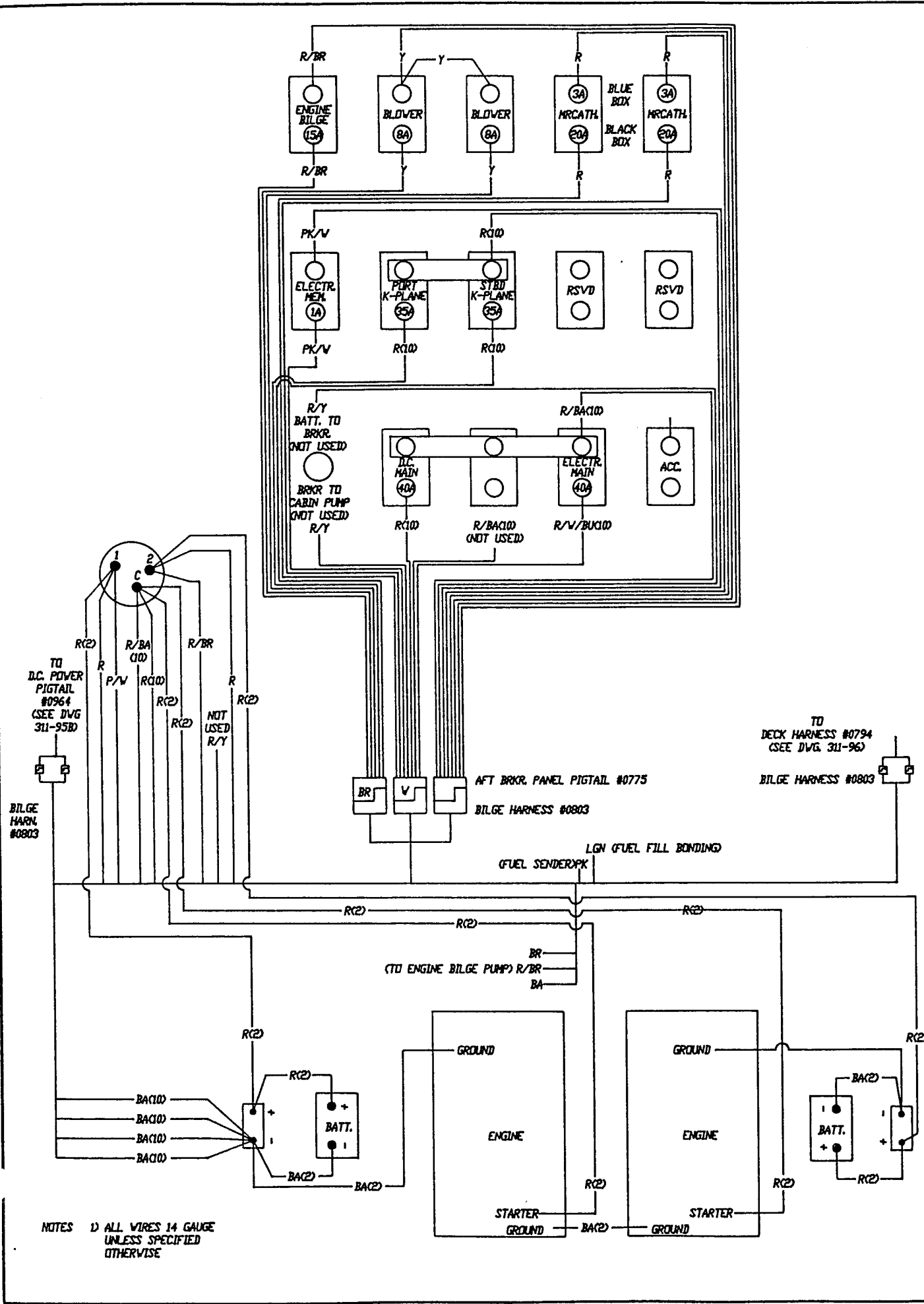

NOTES 1) ALL WIRES 14 GAUGE UNLESS SPECIFIED OTHERWISE

TITLE: F-311 SRT BILGE WIRING DIAGRAM	
DR BY: KKR	CH BY: [Signature]
DATE: 2/15/88	NO.: 311-951
TO HIN #	FROM HIN #
TO HIN #	FROM HIN #
TO HIN #	FROM HIN #
TO HIN #	FROM HIN #
DR	CH DATE
	MY89
REVISIONS	
4	
3	
2	
1	
THUNDERBIRD PRODUCTS P.O. BOX 501 DECATUR, IN 46733 (219) 724-9111	

NOTES  
 1) ALL WIRES 14 GAUGE UNLESS SPECIFIED OTHERWISE.

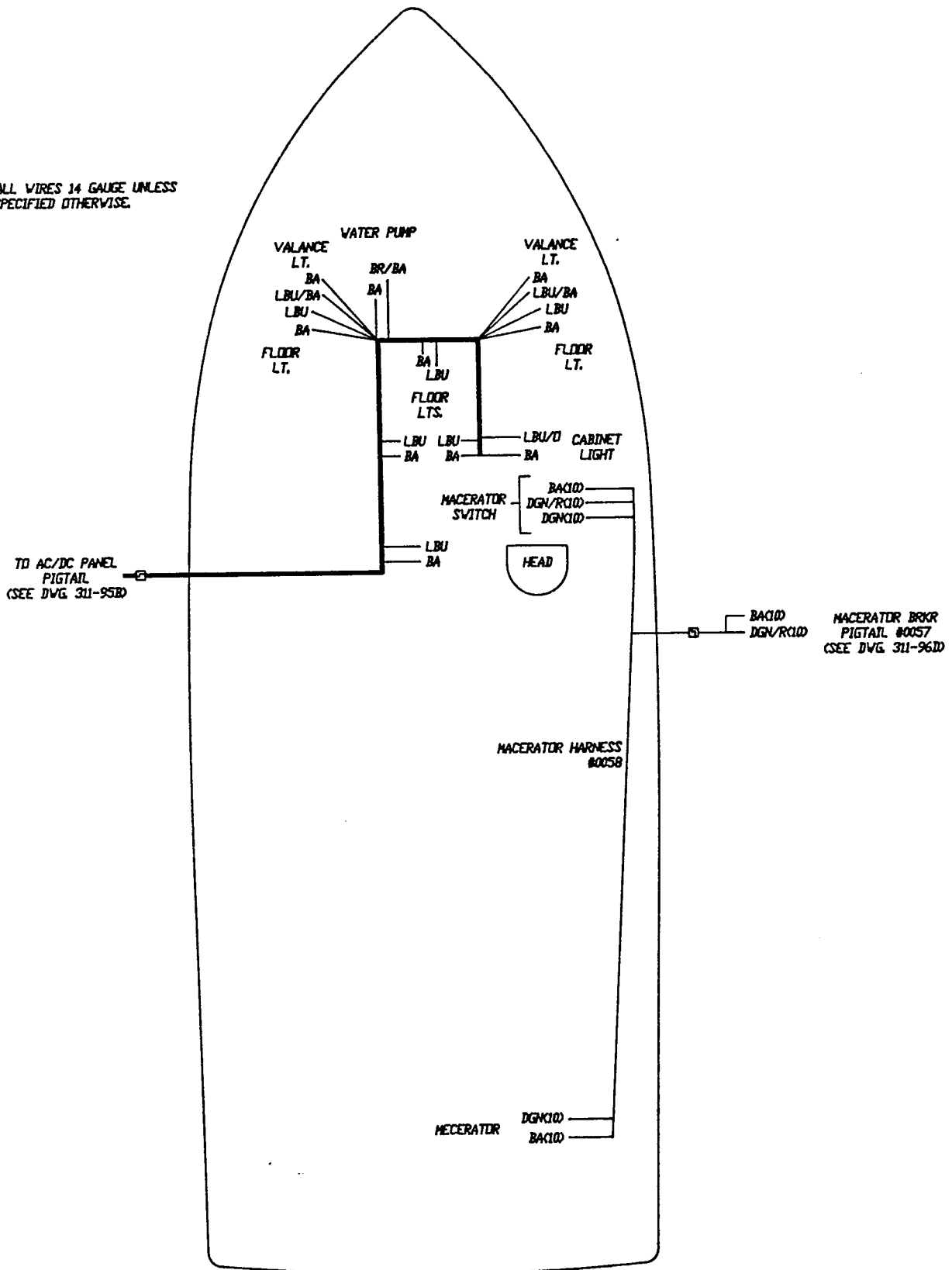

TITLE: F-311 SRT		HULL LAYOUT WIRING DIAGRAM		DR BY: KKR CH BY: JLC		DATE: 2/9/88		NO.: 311-95	
TO HIN #	FROM HIN #	TO HIN #	FROM HIN #	TO HIN #	FROM HIN #	TO HIN #	FROM HIN #	DATE	REVISIONS
									4
									3
									2
									1
									1

THUNDERBIRD PRODUCTS  
 P.O. BOX 501  
 DECATUR, IN 46733  
 (219) 724-9111

FROM BILGE HARNESS #0803  
 (SEE DVG. 311-96)

FROM DC POWER  
 PIGTAIL #0964

NOTES

- 1) ALL AC WIRE IS 12 AWG UNLESS SPECIFIED OTHERWISE.
- 2) ALL DC WIRE IS 14 AWG UNLESS SPECIFIED OTHERWISE.

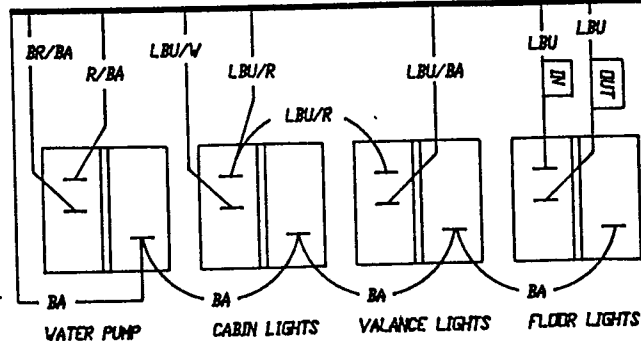
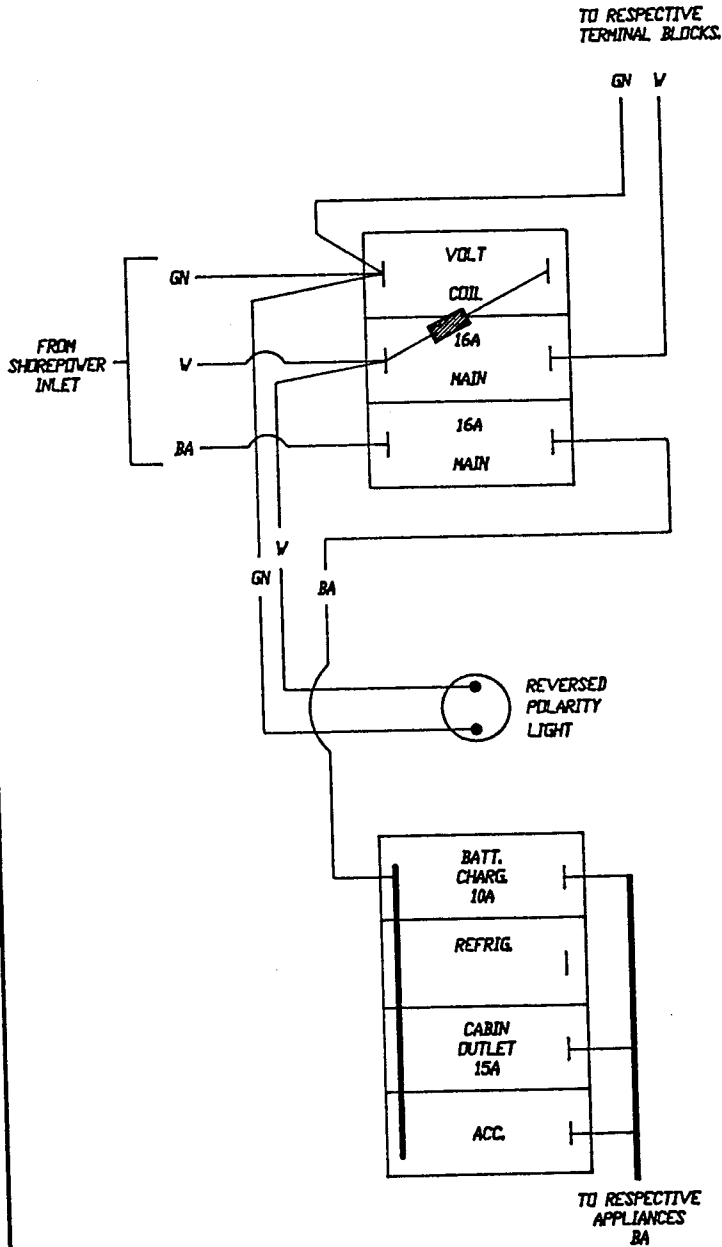

AC/DC PANEL PIGTAIL #0776 (SEE DVG.311-95B)

GALLEY HARNESS #0774 (SEE DVG.311-95B)

TITLE: F-311 SRI  
 AC/DC PANEL WIRING  
 DIAGRAM (220 VAC)  
 DR BY: KKR CH BY: JZ  
 DATE: 02/28/88 NO.: 311-956g

REV	DATE	CH	DR	TO HIN #	FROM HIN #
1					
2					
3					
4					

REVISIONS

THUNDERBIRD PRODUCTS  
 P.O. BOX 501  
 DECATUR, IN 46733  
 (219) 724-9111

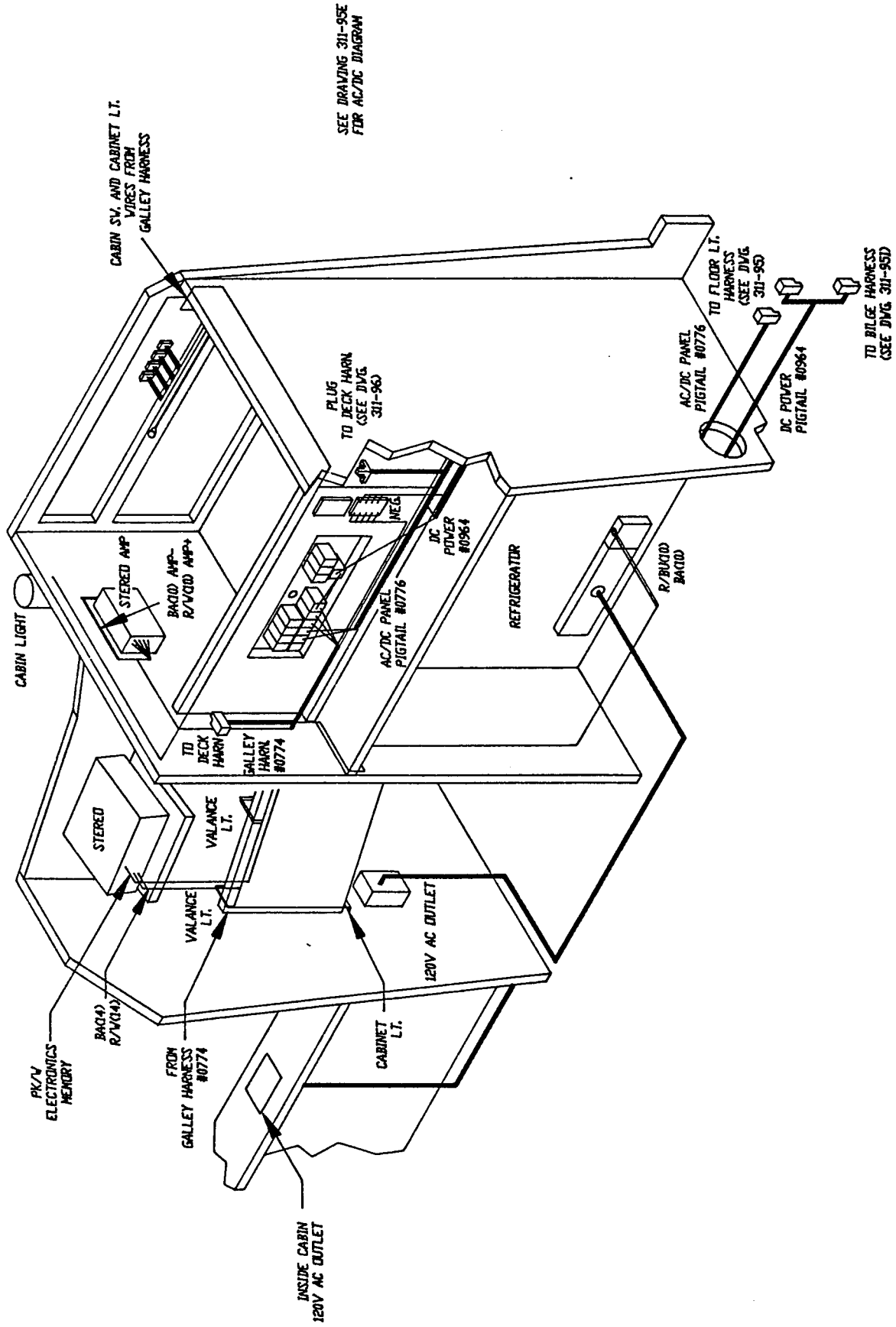

THUNDERBIRD PRODUCTS P.O. BOX 501 DECATUR, IN 46733 (219) 724-9111		REVISIONS		DR	CH	DATE	FROM HIN #	TO HIN #	TITLE: F-311 SRT GALLEY CABINET DIAGRAM
4							FROM HIN #	TO HIN #	
3							FROM HIN #	TO HIN #	
2							FROM HIN #	TO HIN #	
1							FROM HIN #	TO HIN #	DR BY: KKR CH BY: JZ
							FROM HIN #	TO HIN #	DATE: 4/11/88 NO. 311-95B

FROM BILGE HARNESS #0803  
(SEE DVG. 311-96)

FROM DC POWER  
PIGTAIL #0964

NOTES

- 1) ALL AC WIRE IS 12 AWG UNLESS SPECIFIED OTHERWISE.
- 2) ALL DC WIRE IS 14 AWG UNLESS SPECIFIED OTHERWISE.

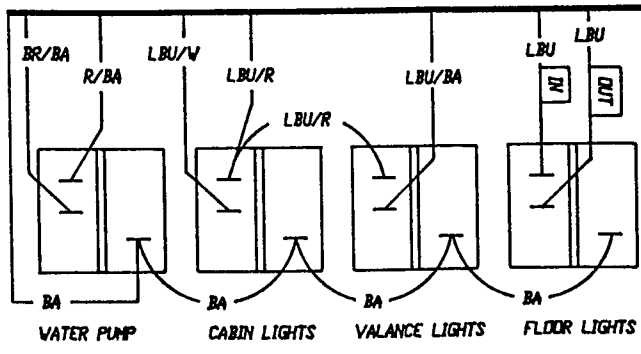
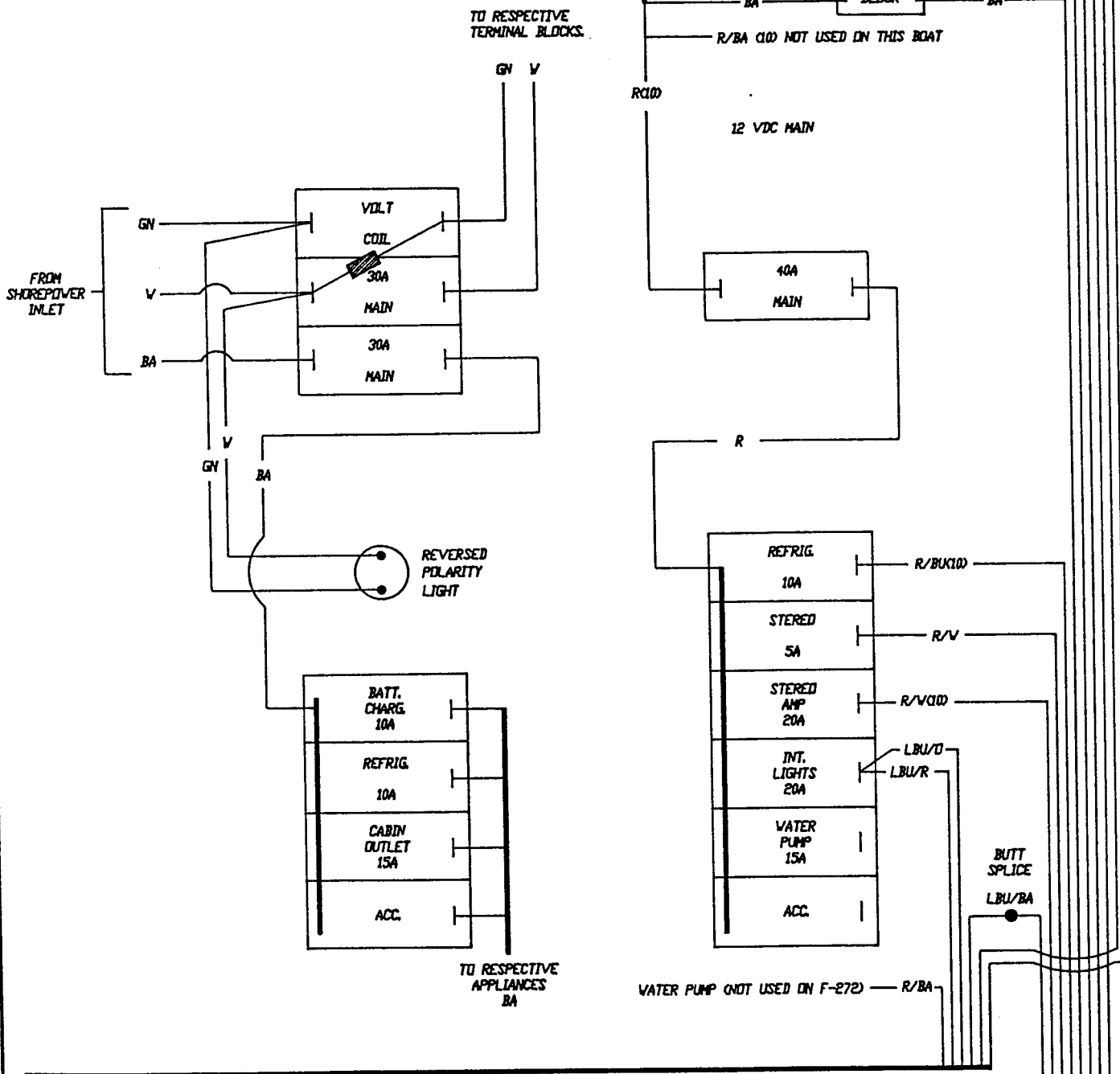

AC/DC PANEL PIGTAIL #0776 (SEE DVG.311-95B) GALLEY HARNESS #0774 (SEE DVG.311-95B)

TITLE: F-311 SRI		TO HIN #	FROM HIN #	DR.	CH.	DATE	REVISIONS
AC/DC PANEL WIRING		TO HIN #	FROM HIN #				
DIAGRAM		TO HIN #	FROM HIN #				
DR. BY: KKR		TO HIN #	FROM HIN #				
CH. BY: JGZ		TO HIN #	FROM HIN #				
DATE: 02/28/88		TO HIN #	FROM HIN #				
INO.: 311-95E		TO HIN #	FROM HIN #				
THUNDERBIRD PRODUCTS		4	3	2	1		
P.O. BOX 501							
DECATUR, IN 46733							
(219) 724-9111							

NOTES:  
 1) ALL WIRES 14 GAUGE UNLESS SPECIFIED OTHERWISE

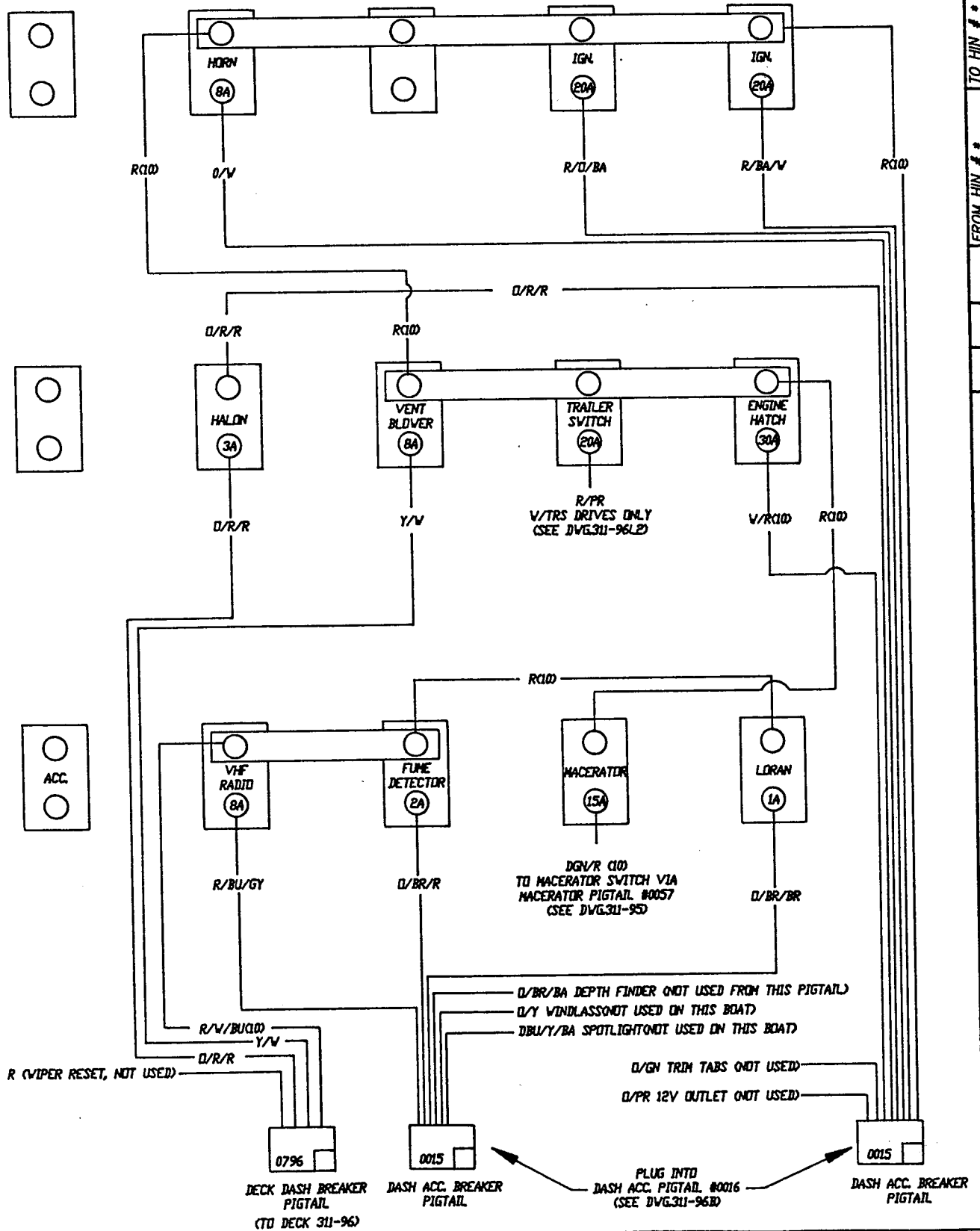

TITLE: F-311 SRI		DASH BREAKER	
PANEL WIRING DIAGRAM		DR. BY: KKR (CH. BY: 2/22)	
DATE: 2/29/88		NO.: 311-96D	
FROM HIN #	TO HIN #	DR	CH
1	1		
2	2		
3	3		
4	4		

REVISIONS

THUNDERBIRD PRODUCTS  
 P.O. BOX 501  
 DECATUR, IN 46733  
 (219) 724-9111





NOTES:

- 1) ALL WIRES DENOTED 'PL' JOINED TOGETHER.
- 2) ALL WIRES 14 GAUGE UNLESS SPECIFIED OTHERWISE.

PORT  
TACHOMETER

SPEEDO

STBD.  
TACHOMETER

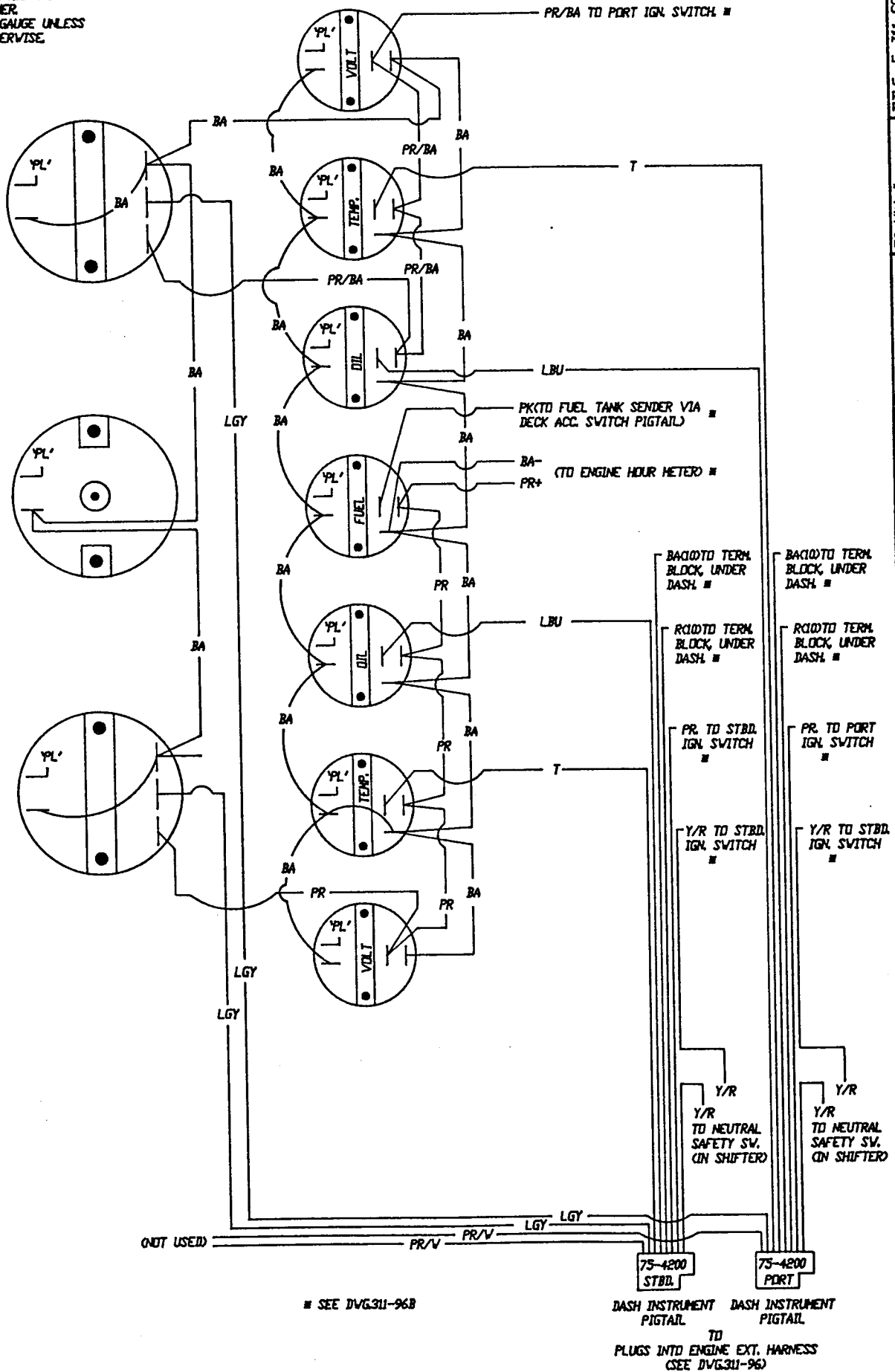

SEE DVG311-96B

DASH INSTRUMENT DASH INSTRUMENT  
PIGTAIL PIGTAIL  
TO  
PLUGS INTO ENGINE EXT. HARNESS  
(SEE DVG311-96)

TITLE: F-311 SRT		TO HIN # *	FROM HIN # *	DR	CH	DATE	REVISIONS
UPPER DASH		TO HIN # *	FROM HIN # *				
WIRING DIAGRAM		TO HIN # *	FROM HIN # *				
DR BY: DLB CH BT: JZ		TO HIN # *	FROM HIN # *				
DATE: 11-1-87 NO. 311-96A		TO HIN # *	FROM HIN # MT89				
4	THUNDERBIRD PRODUCTS						
3	P.O. BOX 501						
2	DECATUR, IN 46733						
1	(219) 724-9111						

D/GN (TO TRIM TAB SWITCHES / NOT USED WITH K-PLANES)  
 CSEE DVG. 311-96L1,96L2

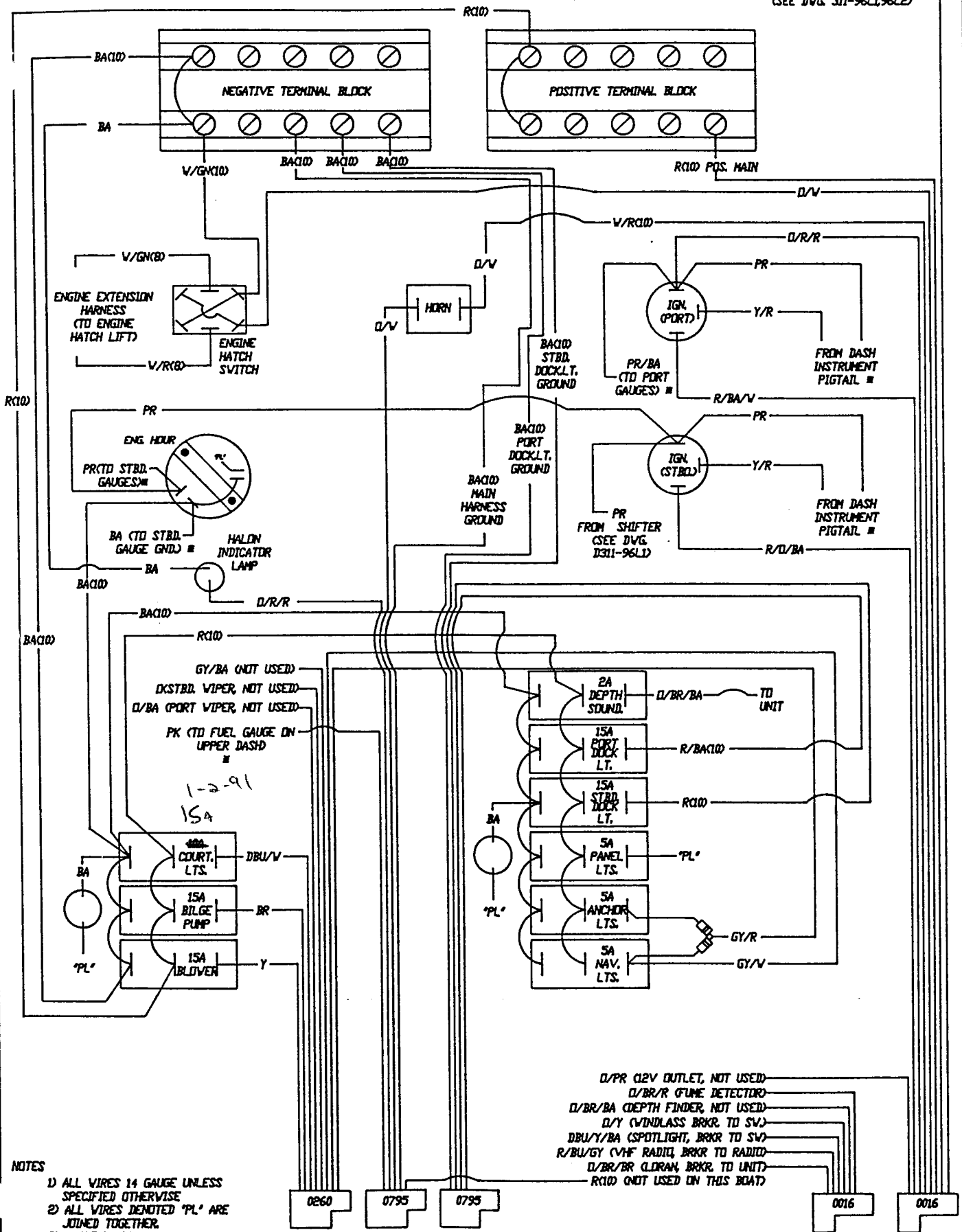

**NOTES**  
 1) ALL WIRES 14 GAUGE UNLESS SPECIFIED OTHERWISE  
 2) ALL WIRES DENOTED 'PL' ARE JOINED TOGETHER  
 3) # SEE DVG.311-96A

DASH ACC. SWITCH PIGTAIL #0260  
 DECK ACC. SWITCH PIGTAIL #0795  
 ALL PLUG INTO DECK HARNESS #1003 (FROM DVG. 311-96)

DASH ACCESSORY PIGTAIL #0016  
 PLUGS INTO DASH ACC. BRKR. PIGTAIL #0015 (FROM DVG. 311-96)

D/PR (12V OUTLET, NOT USED)  
 D/BR/R (FUME DETECTOR)  
 D/BR/BA (DEPTH FINDER, NOT USED)  
 D/Y (WINDLASS BRKR. TO SV)  
 DBU/Y/BA (SPOTLIGHT, BRKR TO SV)  
 R/BU/GY (VHF RADIO, BRKR TO RADIO)  
 D/BR/BR (DRAIN, BRKR. TO UNIT)  
 R/C10 (NOT USED ON THIS BOAT)

TITLE: F-311 SRI LOWER DASH WIRING DIAGRAM		TO HIN #	TO HIN #	TO HIN #	TO HIN #	TO HIN #
DR BY: KKR LCH BY: JZ	DATE: 2-28-88	NO.: 311-96B	FROM HIN #	FROM HIN #	FROM HIN #	FROM HIN #
			CH	DATE	DR	REVISIONS
			4			
			3			
			2			
			1			
THUNDERBIRD PRODUCTS P.O. BOX 501 DECATUR, IN 46733 (219) 724-9111						

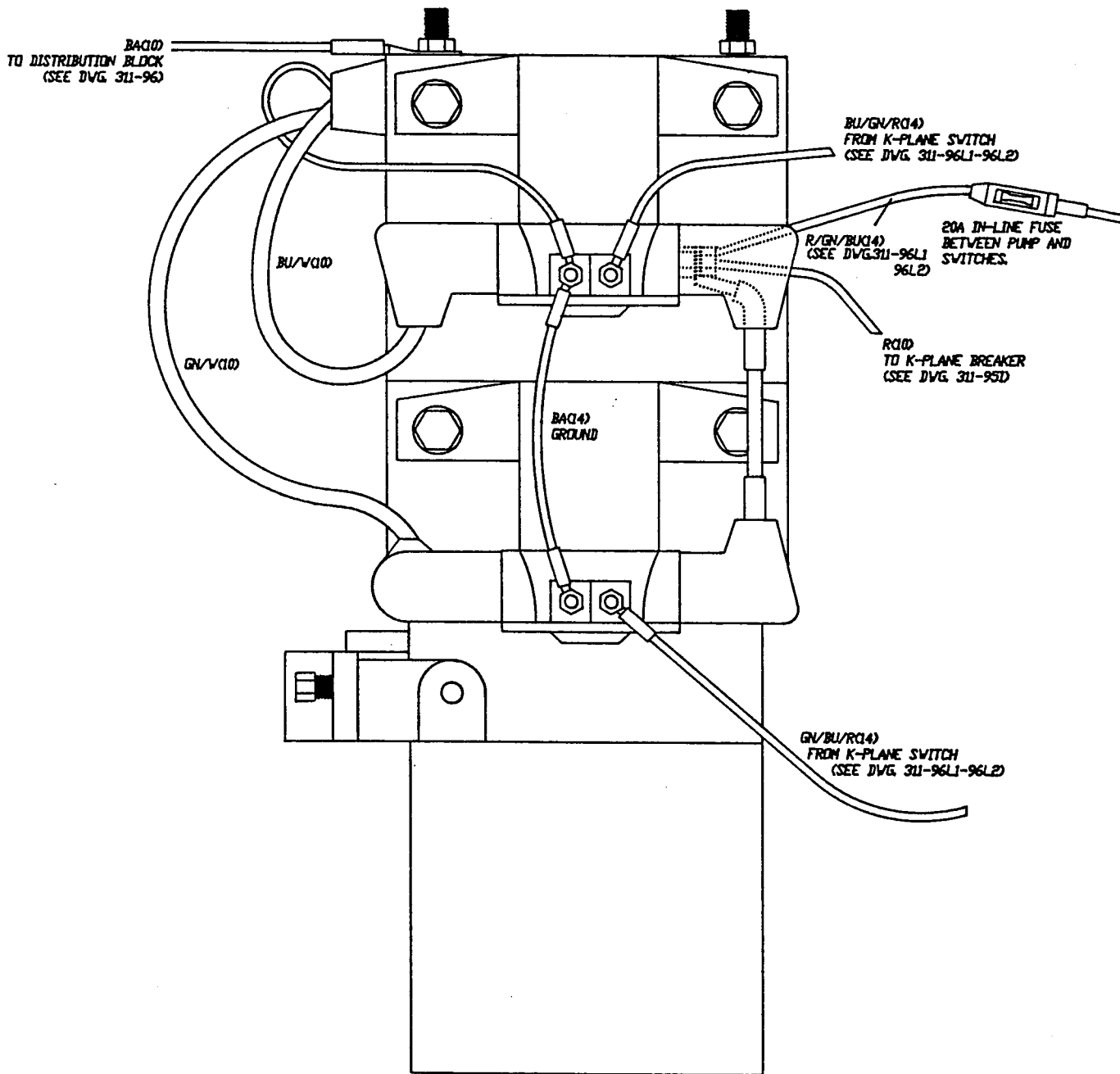

TITLE: F-311 SR1  
 K-PLANE PUMP DIAGRAM  
 DR BY: KKR CH BY: [Signature]  
 DATE: 2/9/88 NO: 311-96E

TO HIN #	TO HIN #	TO HIN #	TO HIN #	TO HIN #
FROM HIN #	FROM HIN #	FROM HIN #	FROM HIN #	FROM HIN #
DATE	DATE	DATE	DATE	DATE
CH	CH	CH	CH	CH
DR	DR	DR	DR	DR

THUNDERBIRD PRODUCTS  
 P.O. BOX 501  
 DECATUR, IN 46733  
 (219) 724-9111

